

Standard Preparation 1900 mm Work Table with Upstand

ITEM # _____

MODEL # _____

NAME # _____

SIS # _____

AIA # _____

133236 (TG1910N)

 Work Table with 100mm
upstand, 1900 mm

Short Form Specification

Item No. _____

The 50mm high worktop in 304 AISI stainless steel, 1mm in thickness, has upturned edges and incorporates a layer of sound deadening, waterproof and fireproof material. Integral radiused rear upstand, h=100mm. Square section legs 40x40mm on 1" height-adjustable feet in 304 AISI stainless steel.

Construction

- 100 mm upstand with 8 mm radiused corner and 13 mm deep, designed to be used against a wall.
- 50 mm worktop in 304 AISI stainless steel, 10/10 in thickness with upturned edges and reinforced waterproof underpanel, incorporates a layer of sound deadening materials.
- Square section legs and 40 mm height-adjustable feet in 304 AISI stainless steel.
- Table top slots into legs without using screws to facilitate installation.
- 400 or 600 mm wide single drawer, chest of 4 drawers, lower shelf, three-sided underframe and set of castors as alternative to the feet, can be fitted as optional on all work tables.
- 40 mm-thick lower shelf (available as optional accessory on some models) slots easily into place at a height of 200 mm from the floor. Lower shelf is compulsory to install the chest of drawers.

Optional Accessories

- Set of 4 wheels (2 with brake) PNC 855150
d. 100mm for tables and sinks
(total height on wheels= 993 mm)
- Single drawer GN 1/1, 400mm PNC 855280
- Single drawer, 600mm PNC 855281
- Additional drawer, 600mm (to PNC 855295
set up a chest of 2, 3, 4 drawers)
- Additional drawer GN 1/1, PNC 855298
400mm (to set up a chest of 2, 3, 4 drawers)
- Lower shelf for 1900 mm tables PNC 855355
and sinks
- 3-sided underframe for PNC 855361
1900mm tables

APPROVAL: _____

Key Information:

External dimensions, Width:	1900 mm
133236 (TG1910N)	1900 mm
External dimensions, Depth:	700 mm
External dimensions, Height:	1000 mm
Upstand Dimensions, Height:	100 mm
Upstand Dimensions, Depth:	13 mm
Upstand Dimensions, Radius:	R=8
Worktop thickness:	50 mm
Net weight:	56 kg

Front

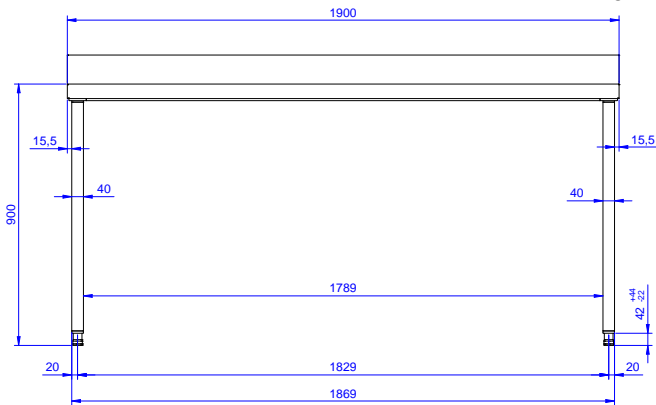

Side

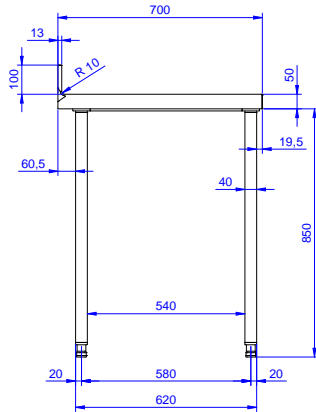

Top

